

Accessories

Modular bus covers

CANopen®

Shaft / end shaft encoders



View inside bus cover

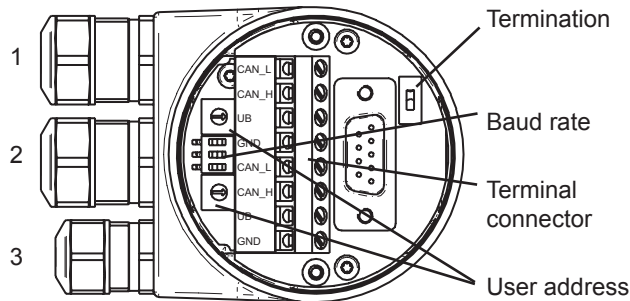

Cable: 1, 2 = \varnothing 8-10 mm (-40-85 °C) / \varnothing 5-9 mm (-25-85 °C)
 Cable: 3 = \varnothing 4.5-6 mm (-40-85 °C) / \varnothing 3-6 mm (-25-85 °C)

Features - CANopen®

Bus protocol	CANopen®
Device profile	CANopen® - CiA DSP 406, V 3.0 (Device Class 2, CAN 2.0B)
Operating mode	Event-triggered Time-triggered Remotely-requested Sync (cyclic) Sync (acyclic)
Preset	Parameter for setting the encoder to a requested position value assigned to a defined shaft position of the system. The offset of encoder zero point and mechanical zero point is stored in the encoder.
Rotating direction	Parameter for defining the rotating direction in which there have to be ascending or descending position values.
Scaling	Parameter defining the steps per turn as well as the total resolution.
Diagnosis	The encoder supports the following error warnings: - Position and parameter error - Lithium battery voltage control (Multiturn)
Node ID monitoring	Heartbeat or Nodeguarding
Default	50 kbit/s, Node ID 1

Part number

Z 163.5P32	CANopen/Cable gland
Z 163.5PA2	CANopen/Connector M12
10140832	CANopen/Cable gland
10147370	CANopen/Cable gland in stainless steel V2A without DUO-LED
10167265	CANopen/Connector M12
10167266	CANopen/Connector M12 in stainless steel V2A without DUO-LED
11048898	CANopen/ATEX cable gland

Bus cover

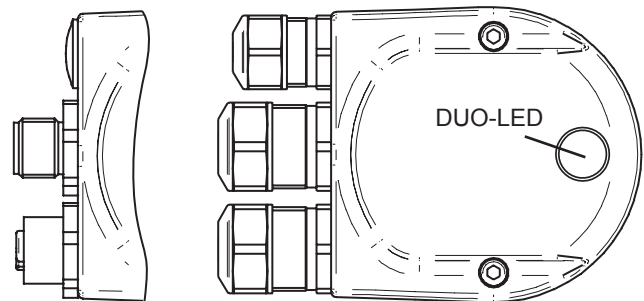

Connector M12 Cable gland

Terminal assignment

Pin 1	GND	Ground connection relating to UB
Pin 2	UB	Voltage supply 10...30 VDC
Pin 3	GND	Ground connection relating to UB
Pin 4	CAN_H	CAN bus signal (dominant High)
Pin 5	CAN_L	CAN bus signal (dominant Low)

Terminals of the same significance are internally connected and identical in their functions. Max. load on the internal terminal connections UB-UB and GND-GND is 1 A each.

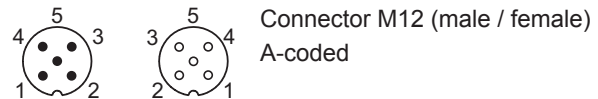

Termination

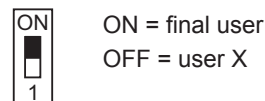

User address (identifier)

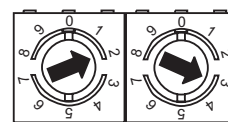

Defined by rotary switch.
Example: User address 23

Baud rate



Baud rate	Dip switch position		
	1	2	3
10 kbit/s	OFF	OFF	OFF
20 kbit/s	OFF	OFF	ON
50 kbit/s	OFF	ON	OFF
125 kbit/s	OFF	ON	ON
250 kbit/s	ON	OFF	OFF
500 kbit/s	ON	OFF	ON
800 kbit/s	ON	ON	OFF
1 MBit/s	ON	ON	ON

If the user address is 00 the baud rate and Node ID are programmable via CAN bus.

Accessories

Modular bus covers

DeviceNet



Shaft / end shaft encoders

View inside bus cover

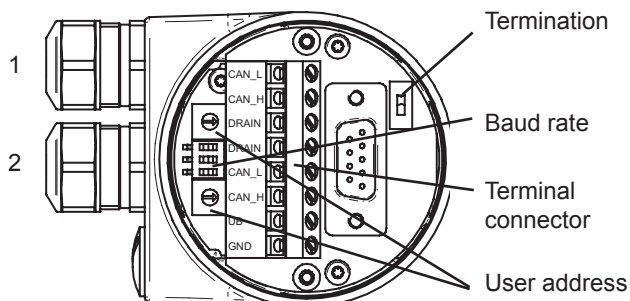

Cable: 1, 2 = ø8-10 mm (-40-85 °C) / ø5-9 mm (-25-85 °C)

Bus cover

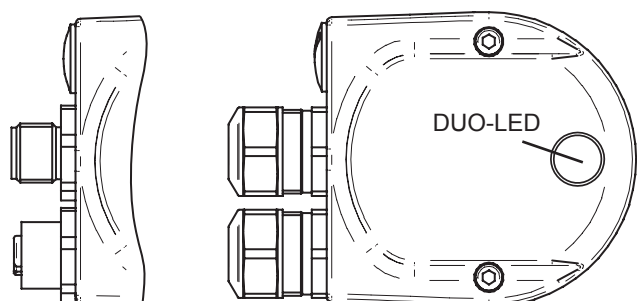

Connector M12 Cable gland

Features - DeviceNet

Bus protocol	DeviceNet
Device profile	Device Profile for Encoders V 1.0
Operating modes	I/O-Polling Cyclic Change of State
Preset	Parameter for setting the encoder to a requested position value assigned to a defined shaft position of the system. The offset of encoder zero point and mechanical zero point is stored in the encoder.
Rotating direction	Parameter for defining the rotating direction in which there have to be ascending or descending position values.
Scaling	Parameter defining the steps per turn as well as the total resolution.
Diagnosis	The encoder supports the following error warnings: - Position and parameter error - Lithium battery voltage control (Multiturn)
Default	125 kbit/s, Mac ID 63

Terminal assignment

Pin 1	DRAIN	Shield
Pin 2	UB	Voltage supply 10...30 VDC
Pin 3	GND	Ground connection relating to UB
Pin 4	CAN_H	CAN bus signal (dominant High)
Pin 5	CAN_L	CAN bus signal (dominant Low)

Terminals of the same significance are internally connected and identical in their functions. Max. load on the internal terminal connections UB-UB and GND-GND is 1 A each.

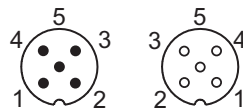

Connector M12 (male / female), A-coded

Termination

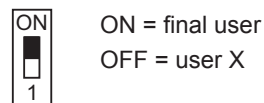

ON = final user
OFF = user X

User address (identifier)

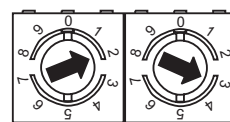

Defined by rotary switch.
Example: User address 23

Part number

Z 163.8P22	DeviceNet/Cable gland
Z 163.8PA2	DeviceNet/Connector M12
10140833	DeviceNet/Cable gland
10147371	DeviceNet/Cable gland in stainless steel V2A without DUO-LED
10167269	DeviceNet/Connector M12
10167273	DeviceNet/Connector M12 in stainless steel V2A without DUO-LED

Baud rate



Baud rate	Dip switch position		
	1	2	3
125 kBit/s	X	OFF	OFF
250 kBit/s	X	OFF	ON
500 kBit/s	X	ON	OFF
125 kBit/s*	X	ON	ON

X = w/o function

* = This switch position is not defined, therefore internally set to default 125 kBit/s.

Accessories

Modular bus covers

Profibus-DPV0



Shaft / end shaft encoders

View inside bus cover

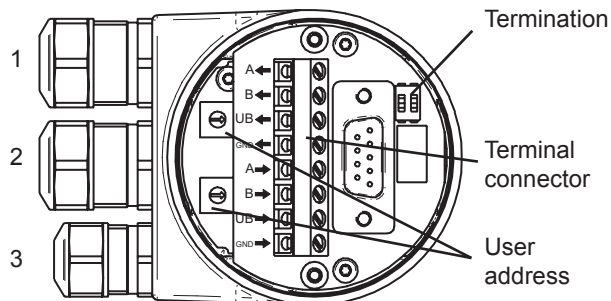

Cable: 1, 2 = \varnothing 8-10 mm (-40-85 °C) / \varnothing 5-9 mm (-25-85 °C)
 Cable: 3 = \varnothing 4.5-6 mm (-40-85 °C) / \varnothing 3-6 mm (-25-85 °C)

Features - Profibus-DPV0

Bus protocol	Profibus-DPV0
Device profile	Device Class 1 and 2
Cyclic data exchange	Communication in line with DPV0
Input data	Position value. In addition optionally speed signal parametering (output of current rotation speed).
Output data	Preset
Preset	Parameter for setting the encoder to a requested position value assigned to a defined shaft position of the system. Storage non-volatile.
Rotating direction	Parameter for defining the rotating direction in which there have to be ascending or descending position values.
Scaling	Parameter defining the steps per turn as well as the total resolution.
Diagnosis	The encoder supports the following error warnings: - Position and parameter error - Lithium battery voltage control (Multiturn)
Default	User address 00 Termination OFF

Part number

Z 163.3P32	Profibus-DPV0/Cable gland
Z 163.3PA2	Profibus-DPV0/Connector M12
10140831	Profibus-DPV0/Cable gland
10147369	Profibus-DPV0/Cable gland stainless steel V2A without DUO-LED
10167254	Profibus-DPV0/Connector M12
10167256	Profibus-DPV0/Connector M12 stainless steel V2A without DUO-LED
11048897	Profibus-DPV0/ATEX cable gland

Bus cover

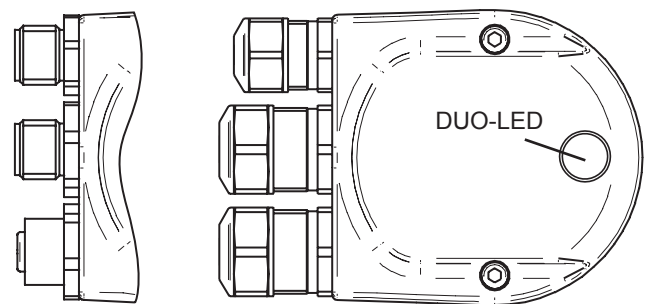

Connector M12 Cable gland

Terminal assignment

Connector M12 (male), A-coded

Pin 1	UB	Voltage supply 10...30 VDC
Pin 3	GND	Ground connection relating to UB

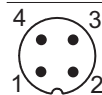

Connector M12 (male / female), B-coded

Pin 2	A	Negative data line
Pin 4	B	Positive data line

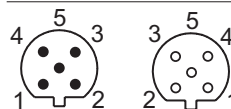

Terminals of the same significance are internally connected and identical in their functions. Max. load on the internal terminal connections UB-UB and GND-GND is 1 A each.

Termination

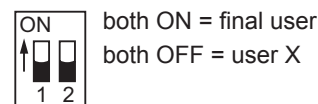

User address (identifier)

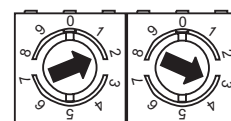

Defined by rotary switch.
 Example: User address 23

Accessories

Modular bus covers

Profibus-DPV2



Shaft / end shaft encoders

View inside bus cover

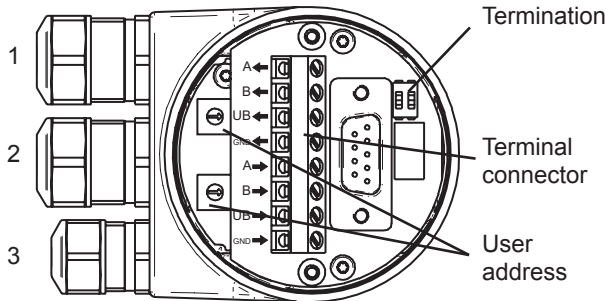

Cable: 1, 2 = \varnothing 8-10 mm (-40-85 °C) / \varnothing 5-9 mm (-25-85 °C)
 Cable: 3 = \varnothing 4.5-6 mm (-40-85 °C) / \varnothing 3-6 mm (-25-85 °C)

Features - Profibus-DPV2

Bus protocol	Profibus-DPV2
Device profile	Device Class 3 and 4
Cyclic data exchange	Communication by synchronous clock (IsoM) in line with DPV2 DXB (cross traffic): publisher function
Acyclic data exchange	I&M (Identification and Maintenance) Functions
Input data	Position value. In addition optionally speed signal parametering (output of current rotation speed).
Output data	Preset
Preset	Parameter for setting the encoder to a requested position value assigned to a defined shaft position of the system. Storage non-volatile.
Rotating direction	Parameter for defining the rotating direction in which there have to be ascending or descending position values.
Scaling	Parameter defining the steps per turn as well as the total resolution.
Diagnosis	The encoder supports the following error warnings: - Position and parameter error - Lithium battery voltage control (Multiturn)
Default	User address 00 Termination OFF

Part number

Z 163.3V32	Profibus-DPV2/Cable gland
Z 163.3VA2	Profibus-DPV2/Connector M12
10167260	Profibus-DPV2/Cable gland
10167262	Profibus-DPV2/Cable gland stainless steel V2A without DUO-LED
10167281	Profibus-DPV2/Connector M12
10167263	Profibus-DPV2/Connector M12 stainless steel V2A without DUO-LED

Bus cover

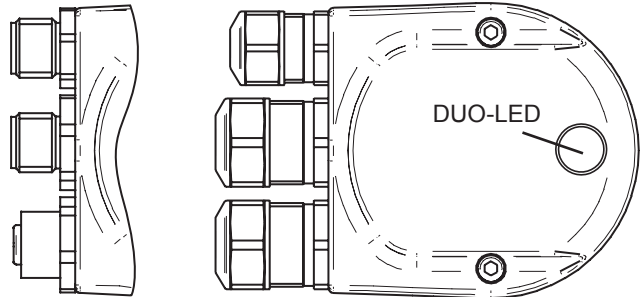

Connector M12 Cable gland

Terminal assignment

Connector M12 (male), A-coded

Pin 1	UB	Voltage supply 10...30 VDC
Pin 3	GND	Ground connection relating to UB



Connector M12 (male / female), B-coded

Pin 2	A	Negative data line
Pin 4	B	Positive data line

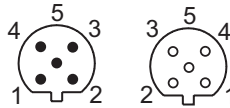

Terminals of the same significance are internally connected and identical in their functions. Max. load on the internal terminal connections UB-UB and GND-GND is 1 A each.

Termination



both ON = final user
 both OFF = user X

User address (identifier)

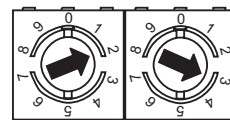

Defined by rotary switch.
 Example: User address 23

Accessories

Modular bus covers

EtherCAT

Shaft / end shaft encoders



View inside bus cover

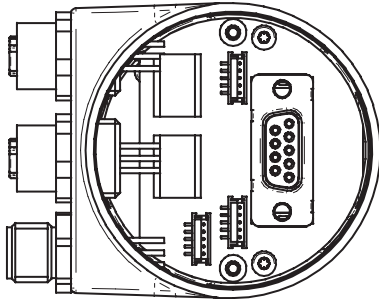

Bus cover

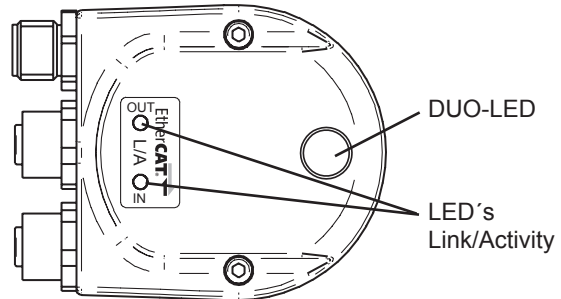

Features - EtherCAT

Bus protocol	EtherCAT
Device profile	CoE (CANopen over EtherCAT) DSP406
Features	<ul style="list-style-type: none"> - 100 MBaud Ethernet - Automatic address designation - Distributed clock for precise synchronization. Optional device configuration as „Reference Clock“ - Default 10 byte PDO, configurable 4 byte PDO / 2 byte PDO for shorter cycle times
Process data	Position value Warnings System time
Cycle times	Depending on sensor type, enabled scaling functionality and length of PDO. Min. cycle time: 62,5 µs
Synchronization	0x00 Free Run, not synchronized 0x03 Distributed clocks DC, synchronized with SYNCO/SYNC1 Event

Part number

Z 163.EPA6 Bus cover EtherCAT

Terminal assignment

Voltage supply

Terminal	Assigned	Significance
Pin 1	UB	Voltage supply
Pin 2	N.C.	Not assigned
Pin 3	GND	Ground
Pin 4	N.C.	Not assigned

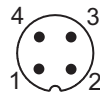

1 x Connector M12 (male), A-coded

EtherCAT (data line)

Terminal	Assigned	Significance
Pin 1	TxD+	Transmission data+
Pin 2	RxD+	Receiving data+
Pin 3	TxD-	Transmission data-
Pin 4	RxD-	Receiving data-

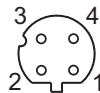

2 x Connector M12 (female), D-coded

Accessories

Z 185.E05	Connector M12, on both sides, CuZn nickel-plated/TPU, 5 m cable PUR (data line)
Z 185.P05	Connector M12, CuZn nickel-plated/TPU, 5 m cable PUR, 360° screen (voltage supply)

Accessories

Modular bus covers

PoE - Power over EtherCAT

Shaft / end shaft encoders

View inside bus cover

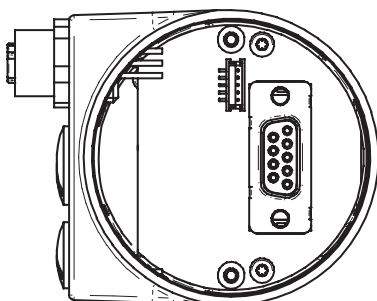

Bus cover

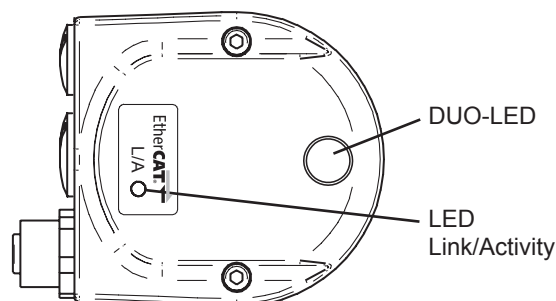

Features - Power over EtherCAT

Bus protocol	EtherCAT
Device profile	CoE (CANopen over EtherCAT) DSP406
Features	<ul style="list-style-type: none"> - 100 MBaud Ethernet - Automatic address designation - Distributed clock for precise synchronization. Optional device configuration as „Reference Clock“ - Default 10 byte PDO, configurable 4 byte PDO / 2 byte PDO for shorter cycle times
Process data	Position value Warnings System time
Cycle times	Depending on sensor type, enabled scaling functionality and length of PDO. Min. cycle time: 62,5 µs
Synchronization	0x00 Free Run, not synchronized 0x03 Distributed clocks DC, synchronized with SYNCO/SYNC1 Event
Function PoE	Compliant to standard IEEE Std 802.3af
Excess temperature	Protection against excess temperature
PoE mains unit	Galvanically insulated
Hot-Connect	Connecting/disconnecting the device during operation

Technical data - Power over EtherCAT

Capacity class	1 (max. 4 W)
Supply voltage	44...57 VDC
Current consumption	≤50 mA (48 VDC)
Cable length	Max. 100 m

Part number

Z 163.EEA2 Bus cover PoE - Power over EtherCAT

Terminal assignment

Terminal	Assigned	Significance
Pin 1	TxD+	Transmission data+
Pin 2	RxD+	Receiving data+
Pin 3	TxD-	Transmission data-
Pin 4	RxD-	Receiving data-



2 x Connector M12 (female), D-coded

Power supply of PSE module (Power Sourcing Equipment) is also by these lines.

Accessories

Z 185.E05 Ethernet cable, connector M12 on both sides with 5 m cable

Accessories

Modular bus covers

PROFINET



Shaft / end shaft encoders

View inside bus cover

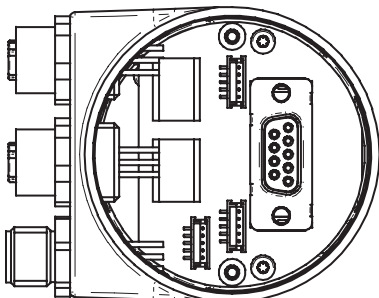

Bus cover

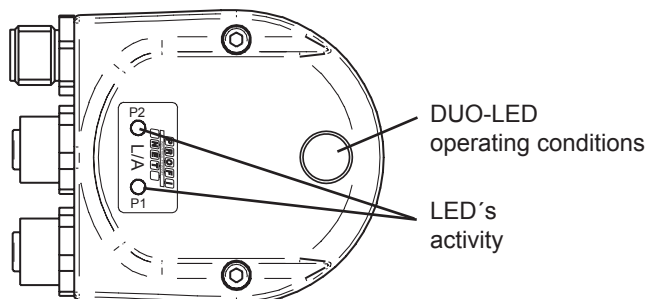

Features - PROFINET

Bus protocol	PROFINET
Device profile	Encoder Profile PNO 3.162
Features	<ul style="list-style-type: none"> - 100 MBaud Fast Ethernet - Automatic address designation - Realtime (RT) Class 1, IRT Class 2, IRT Class 3
Process data	Position value 32 bit input data

Part number

Z 163.3EA2 Bus cover PROFINET

Terminal assignment

Voltage supply

Terminal	Assigned	Significance
Pin 1	UB	Voltage supply
Pin 2	N.C.	Not assigned
Pin 3	GND	Ground
Pin 4	N.C.	Not assigned

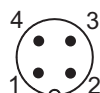

1 x Connector M12 (male), A-coded

PROFINET (data line)

Terminal	Assigned	Significance
Pin 1	TxD+	Transmission data+
Pin 2	RxD+	Receiving data+
Pin 3	TxD-	Transmission data-
Pin 4	RxD-	Receiving data-

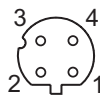

2 x Connector M12 (female), D-coded

Accessories

Z 185.E05	Ethernet cable, connector M12 on both sides with 5 m cable (data line)
Z 185.P05	Connector M12 with 5 m cable, 360° screen (current line)

Accessories

Modular bus covers

EtherNet/IP



Shaft / end shaft encoders

View inside bus cover

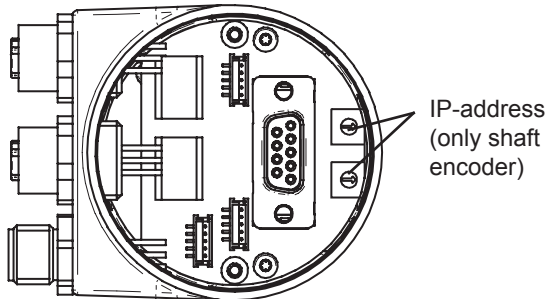

Bus cover

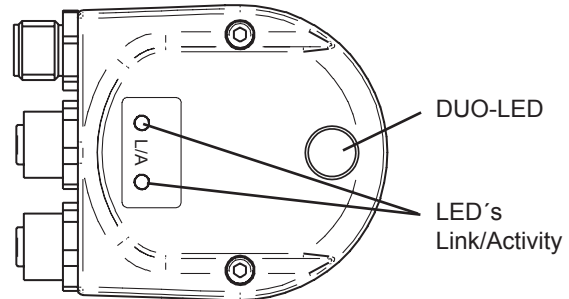

Features - EtherNet/IP

Bus protocol	EtherNet/IP
Device profile	Encoder Device, type 22hex, according to CIP specification
Features	<ul style="list-style-type: none"> - 100 MBaud Fast Ethernet - IP address programmable - Automatic IP address designation (DHCP) - Rotation direction, resolution, total resolution and preset are programmable according to CIP specification
Process data	Position value, Warning Flag, Alarmflag Assembly Instances 1 and 2 according to CIP specification

Part number

Z 163.8EA2 Bus cover EtherNet/IP

Terminal assignment

Voltage supply

Terminal	Assigned	Significance
Pin 1	UB	Voltage supply
Pin 2	N.C.	Not assigned
Pin 3	GND	Ground
Pin 4	N.C.	Not assigned

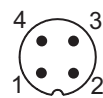

1 x Connector M12 (male), A-coded

EtherNet/IP (data line)

Terminal	Assigned	Significance
Pin 1	TxD+	Transmission data+
Pin 2	RxD+	Receiving data+
Pin 3	TxD-	Transmission data-
Pin 4	RxD-	Receiving data-

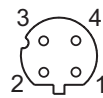

2 x Connector M12 (female), D-coded

IP address

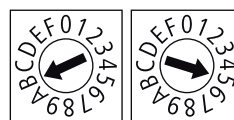

Defined by HEX rotary switch
 Example: IP address B5_{hex}
 Configuration via DHCP: 00_{hex}

Accessories

Z 185.E05	Ethernet cable, connector M12 on both sides with 5 m cable (data line)
Z 185.P05	Connector M12 with 5 m cable, 360° screen (current line)

Accessories

Modular bus covers

POWERLINK

ETHERNET 
POWERLINK

Shaft / end shaft encoders

View inside bus cover

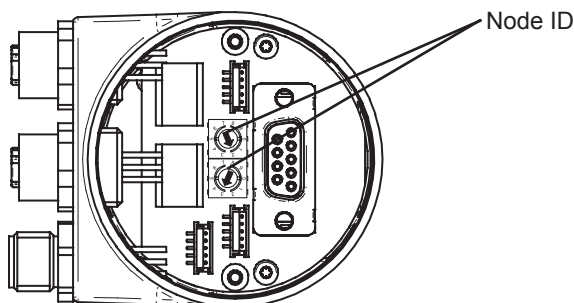

Bus cover

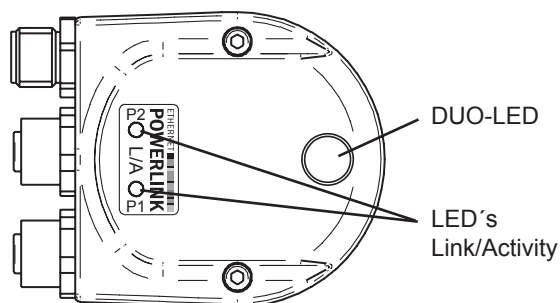

Features - POWERLINK

Bus protocol	Ethernet Powerlink 2.0
Device profile	DSP406
Address	Free configurable via software or rotary switch Standard node 1 Standard IP 192.168.100.1
Features	<ul style="list-style-type: none"> - 100 MBaud Ethernet - Response times <2 μs - Cycle times <200 μs - Jitter from Start of Cycle (SoC) to position detection <200 ns - Daisy Chain is possible - Rotation direction, resolution, total resolution and preset are programmable
Process data	Position value

Part number

Z 163.5EA2 Bus cover POWERLINK

Accessories

Z 185.E05	Ethernet cable, connector M12 on both sides with 5 m cable (data line)
Z 185.P05	Connector M12 with 5 m cable, 360° screen (current line)
133852	Connector M12 straight with 2 m cable, (current line)
133853	Connector M12 straight with 5 m cable, (current line)
135247	Connector M12 straight with 10 m cable, (current line)
160565	Ethernet cable, connector M12 on both sides with 5 m cable (data line)

Terminal assignment

Voltage supply

Terminal	Assigned	Significance
Pin 1	UB	Voltage supply
Pin 2	N.C.	Not assigned
Pin 3	GND	Ground
Pin 4	N.C.	Not assigned

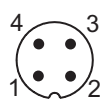

1 x Connector M12 (male), A-coded

POWERLINK (data line)

Terminal	Assigned	Significance
Pin 1	TxD+	Transmission data+
Pin 2	RxD+	Receiving data+
Pin 3	TxD-	Transmission data-
Pin 4	RxD-	Receiving data-

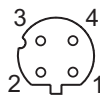

2 x Connector M12 (female), D-coded

Node ID

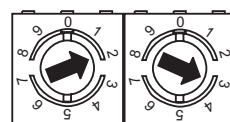

Defined by rotary switch.
 Example: User address 23.
 If the rotary switch 00 the Node ID are programmable via bus.

Accessories

Modular bus covers

SAEJ1939

Shaft / end shaft encoders

SAEJ1939

View inside bus cover

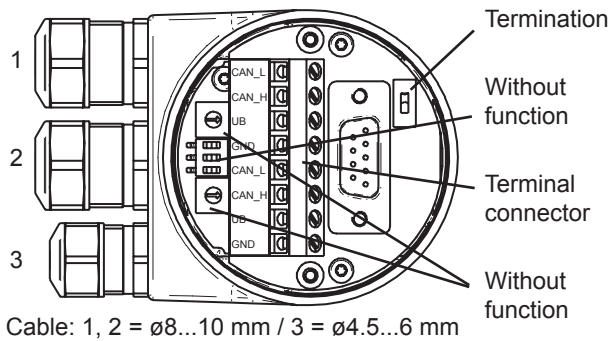

Bus cover

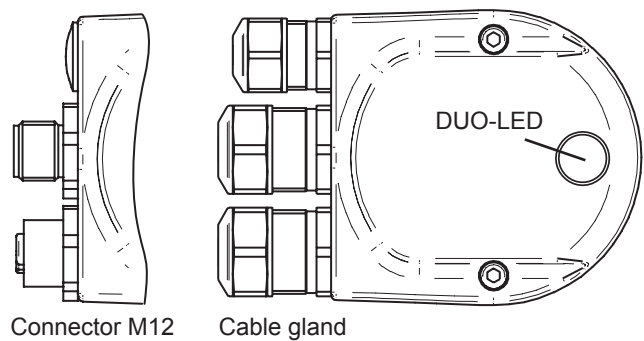

Features - SAE J1939

Bus protocol	SAE J1939
Device profile	Industry Group 5, Industrial, Process control
Operating mode	Time-triggered, On Request
Preset	Parameter for setting the encoder to a requested position value assigned to a defined shaft position of the system. The offset of encoder zero point and mechanical zero point is stored in the encoder.
Rotating direction	Parameter for defining the rotating direction in which there have to be ascending or descending position values.
Scaling	Parameter defining the steps per turn as well as the total resolution.
Diagnosis	The encoder supports the following error warnings: - Position and parameter error - Lithium battery voltage control (Multiturn)
Node ID monitoring	Heartbeat or Nodeguarding
Cycle time	Repetition rate for data: position, speed, diagnostic

Part number

Z 163.5B32	SAEJ1939/Cable gland
Z 163.5BA2	SAEJ1939/Connector M12

Terminal assignment

Pin 1	GND	Ground connection relating to UB
Pin 2	UB	Voltage supply 10...30 VDC
Pin 3	–	–
Pin 4	CAN_H	CAN bus signal (dominant High)
Pin 5	CAN_L	CAN bus signal (dominant Low)

Terminals of the same significance are internally connected and identical in their functions. Max. load on the internal terminal connections UB-UB and GND-GND is 1 A each.

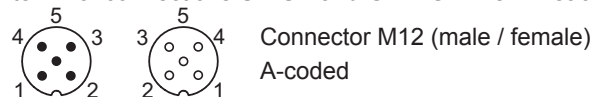

Termination



J1939 Definitions (Default settings)

Baud rate	250 kbit/s
Address	172 (0xAC)
Arbitrary address capable	1
Industry Group	5
Vehicle System	0
System Instance, ECU instance	0
Function	142 (0x8E)
Function instance	0
Manufacturer	343 (0x157)
Identity Number	Device-individual
PGN 65450: encoder position, speed, diagnostic	Proprietary B, Broadcast communication
Transmission repetition rate	50 ms
Data length	8 bytes
PDU format PF	255 (0xFF)
PDU specific PS	0xAA
Default priority	6
Parameter group number PGN	65450 (0xFFAA)